

TELESIS

PX24N Nano

Hybrid IP PBX



Designer and Manufacturer:

Telesis Telekomunikasyon Sistemleri San. Ve Tic. A.S.

Iskitler Cad. , No:68, Ankara, 06060 - TURKEY

Tel: +90 312 384 0540

Fax: +90 312 384 0549

<http://www.telesis-pbx.com>



PX24N Short Manual Edition 1.00 © Telesis A.S., 2012. Subject to change without any notice.

THANK YOU

... for purchasing the Telesis PX24N Hybrid IP PBX. It is manufactured to the highest quality standards and tested vigorously to comply with requirement for its product specifications.

In this manual, you will find basic information about the PX24N. We hope that this simplified manual will get you started and help you familiarize with your new hybrid IP PBX system.

For further technical resources, we strongly recommend you to visit our WIKI pages at:

<http://wiki.telesis-pbx.com>

To remind you, for the appropriate operation of your new hybrid IP PBX, it may need programming and/or licensing.

We hope that your PX24N Hybrid IP PBX will serve you well and provide you with all your communication needs now and in the future.

Telesis Telekomunikasyon Sistemleri San. ve Tic. A.S.

PX24N HALLMARKS

- Converged communications system with TDM and IP connectivity at the same time
- Sleek box design, featuring an executive digital phone (with 4.3 inch TFT LCD video display, polyphonic ring melodies and many more)
- Easy installation without any special tools
- Powerful Xymphony operating firmware
- Both H.323 and SIP protocols at the same time
- IP subscribers and trunks at the same time
- Low power consumption
- Cost-effective

PX24N FACTORY DEFAULTS

- IP address: 10.0.0.12
- Homepage: <http://10.0.0.12/xp.asp>
- Subnet Mask: 255.255.255.0
- Gateway: 10.0.0.138

PACKAGE CONTENTS

PX24N rev.6 IP PBX package may include the following items:

- PX24N IP PBX body, which is integrated into a digital executive telephone set
- AC Mains power adapter
- Handset
- Coilcord for the handset
- Cross-connected ethernet cable (may be used for direct connection between a computer and the PX24N)
- Spare name sticker
- Manual

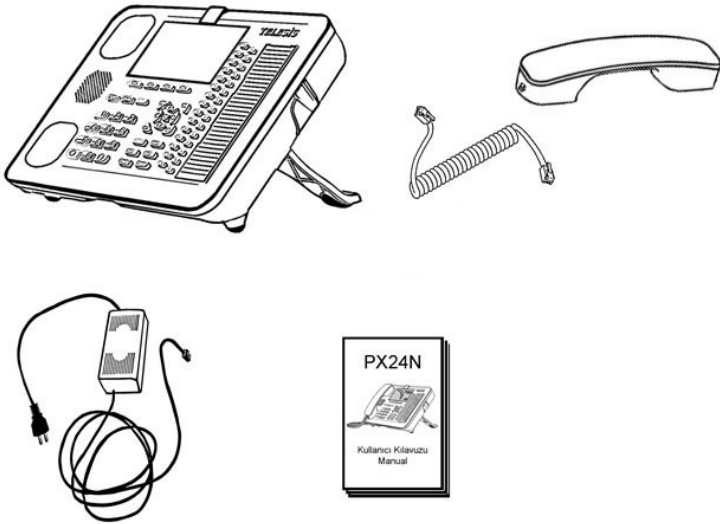

Important Notes:

- Be aware that package contents may vary according to the different regions or countries. You may check with your local resellers or dealers for the contents.
- Depending on your system specifications, components that come with your order may vary, please check your shipping list for a full description of what was included in your package.

WARNINGS

Be Aware:

- Please read all documentation in this wiki carefully.
- Avoid exposure to heat sources or direct sunlight for your PX24N rev.6.
- You may clean only the surface of your PX24N with a damp dust-cloth.
- Never use any chemicals for cleaning.
- Be careful not to spill any liquid on your PX24N.
- Be careful to place your PX24N on a flat and non-vibrating, stable surface. Dropping the equipment may cause unrepairable damage.
- Be careful to place your PX24N away from:
 - High voltage lines, smoke, dust, gas or radiation (such as a generator, photocopier etc.)
 - Radio equipment that generates or emits high level signals
 - Sever, pipes, or valves that could leak or cause condensation
- Never connect any connectors on your PX24N to the MAINS or any other high voltage or current sources.
- Always use the original mains power adapter with your PX24N.
- Your PX24N does not contain any parts for maintenance. In case of any failure, do not open any covers of your PX24N. Please contact your local Telesis Dealer for his assistance.
- Do not loosen any screws on your PX24N.

More About Cleaning

You may clean your PX24N if it is necessary only. Disconnect all cords, wires and mains power adapter from the body of your PX24N before cleaning. Clean only the surface of your PX24N with a damp dust-cloth . Never use any chemical cleaners (liquid or spray). Make sure the surface is dry before re-connecting the power and line cords.

More About Maintenance

Your PX24N does not contain any parts for periodic maintenance. Consequently, periodic maintenance is not a condition at all. However, you may prefer (or need) some maintenance of your PX24N for some reason. Please contact your local Telesis Dealer for his assistance then. In any case, never do this by yourself. Do not open any covers of your PX24N. Do not tighten any screws on your PX24N.

Recommended Environmental Conditions

- Temperature range: 0-40 °C
- Humidity range: %0-85 (non-condensing)

CONNECTORS

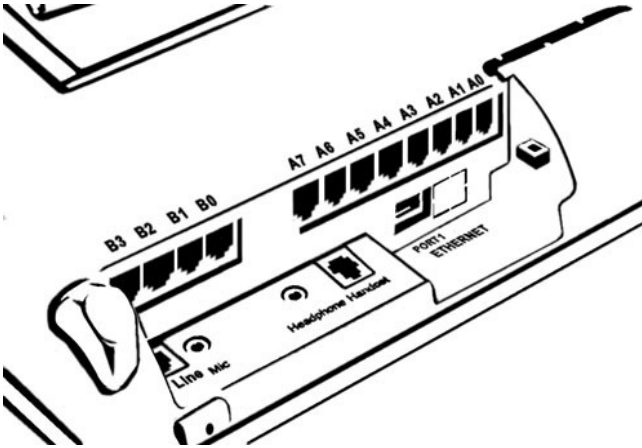

B0 B1 B2 B3	Connectors for FXO (analog trunk, PSTN) lines
A0 A1 A2 A3 A4 A5 A6 A7	Connectors for FXS (analog subscriber) lines
Line	Connector for power adapter. Always use the original mains power adapter with your PX24N. Otherwise, you may damage your system
Mic	External microphone connector
Headphone	External headset speaker (headphone) connector
Handset	Handset connector
PORT1	10-100 BaseT Ethernet connector

ADJUSTING THE BODY ANGLE

For your comfort;

- with your hand, loose the screw of the stand attached to the body,
- adjust the angle of the stand for the best position,
- tighten the screw with your hand to hold the stand angle.

Do not use any tools to loose and tighten the screw. Loose and tighten gently. Be aware that over-torque may cause a damage.

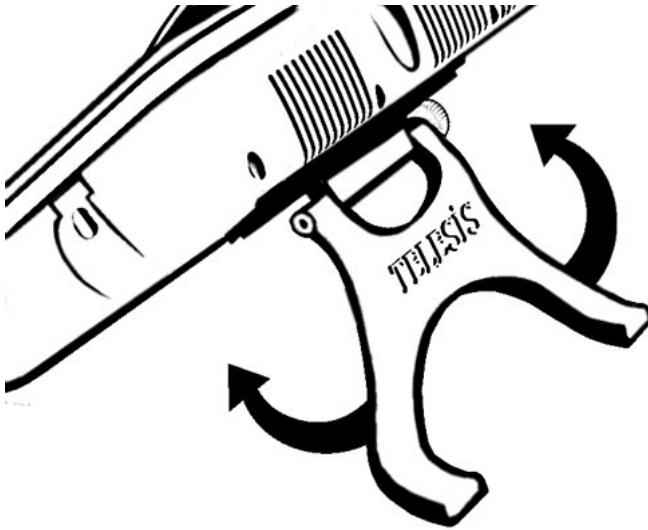

WALL MOUNTING

The PX24N rev.6 can be mounted on the wall simply by

- drilling two holes on the wall,
- placing screws to the holes,
- removing the stand from the PX24N,
- hanging the PX24N on these screws.

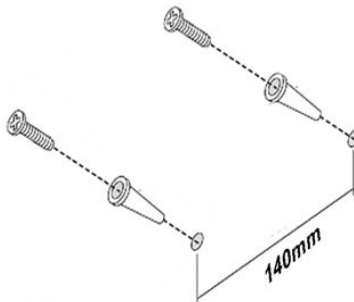

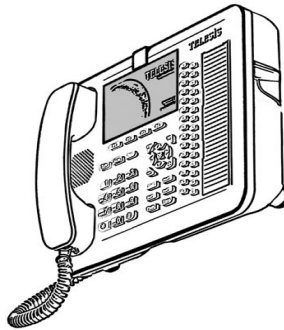
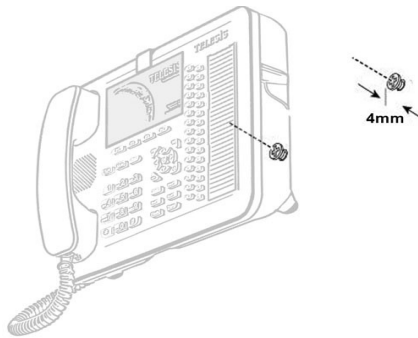
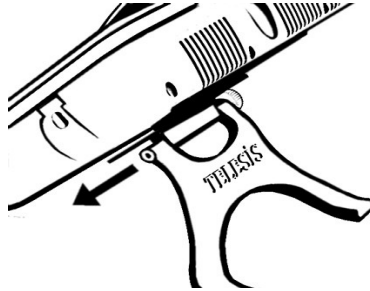

Specifications

LCD Type	Color TFT
LCD Resolution	480x272
LCD Protection	PMMA
External Microphone Jack	Popular 3.5mm TS connector
External Meadphone Jack	Popular 3.5mm TS connector
Stand and Handset Plastic Thickness	3mm
Stand Mount	Desktop Mount or Wall Mount
Stand Mount Angle	Continuously Adjustable
Number of Keys	64 keys in total
Navigation Keys	Yes
Quick Access Keys	Backlighted 30 keys for quick access (120 quick access with using the Shift key)
Busy Display Panel	Yes
Programmable Function Keys	Yes
Handsfree, Mute, Record Keys	Yes
Total Weight Including Handset	1550 grams
Handset Weight	235 grams
External Power Adapter Weight	450 grams
Dimensions	27.6 x 23.3 x 6.5 cm (wxhxd)

Capacities

Analog subscribers (FXS)	8
Digital subscriber (PX24N itself)	1
Analog DC loop trunks (FXO)	4
SIP users	32 independently programmable SIP users (local or remote, subscriber or trunk)
H.323 users	32 independently programmable H323 users (local or remote, subscriber or trunk)
Telesis xSIP users	32 (1 by default, more with licensing)
VoIP - TDM gateway channels	up to 12 with licensing (increased in multiples of 2)
Xymphony-API clients	unlimited
DVR recording capacity	100 hours (6000 minutes)
DVR recording channels	4
DVR playing channels	4
DTMF transceivers	non-blocking
Caller ID transmitters	non-blocking
Caller ID receivers	non-blocking